

- **INSIDE / OUTSIDE CORNER MOLDING 96.00"**
This product is used to trim the inside and outside edge of ninety degree corners.

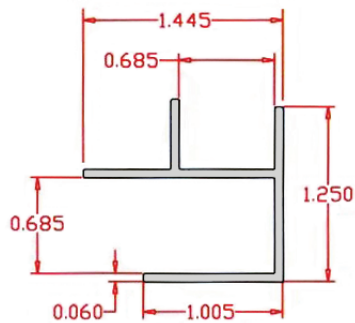

- **PART NUMBERS**
HST1008M White
HST2008M Taupe HST4008M Black
HST3008M Gray HST9008M Maple

- **WIDE CORNER MOLDING 120.00"**
This product is used to trim out ninety degree corners. This product can be affixed with adhesive or screws.

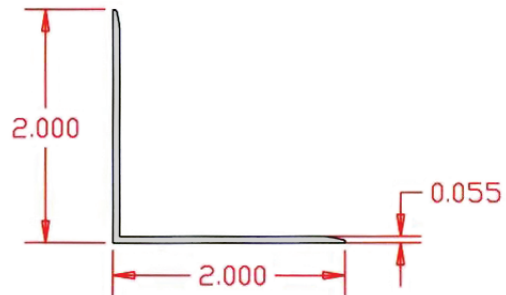

- **PART NUMBERS**
HST1008C White
HST2008C Taupe HST4008C Black
HST3008C Gray HST9008C Maple

- **J MOLDING 96.00"**
This product is used to trim the edges of Handiwall when installed around doors, windows, etc. This product can be used to frame Handiwall panels.

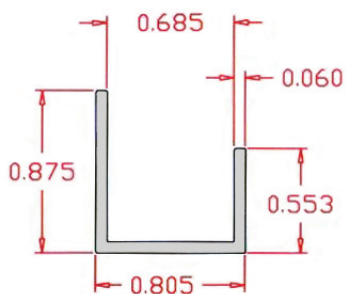

- **PART NUMBERS**
HST1008J White
HST2008J Taupe HST4008J Black
HST3008J Gray HST9008J Maple

- **INDENTED EDGE CAP 96.00"**
This product is used to trim the edges of Handiwall when installed around doors, windows, etc. This product can be used to frame Handiwall panels.

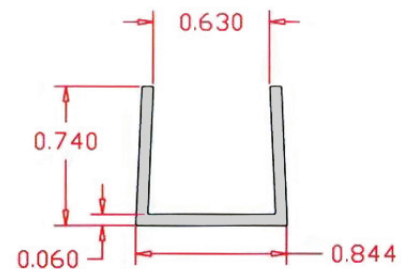

- **PART NUMBERS**
HST1008E White
HST2008E Taupe HST4008E Black
HST3008E Gray HST9008E Maple

• **LARGE J MOLDING 120.00"**

This product is used to trim the edges of Handiwall when installed around doors, windows, etc. Offers an easier installation due to the large back wall of profile that can be easily attached with adhesive or screws.

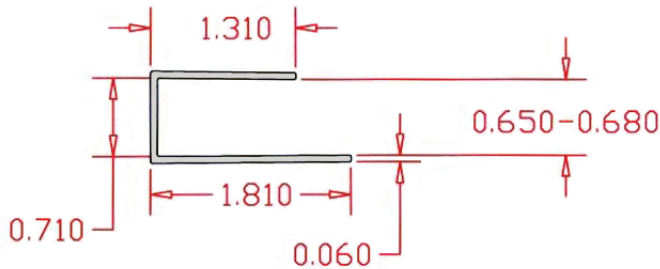

• **PART NUMBERS**

HST1008L White	HST4008L Black
HST2008L Taupe	HST5008L Burgundy
HST3008L Gray	HST9008L Maple

• **T MOLDING 120.00"**

This product is used to cover the seams of the Handi-wall panels.

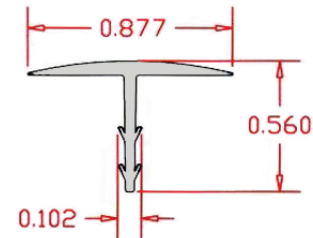

• **PART NUMBERS**

HST1008T White	HST9008T Maple
HST2008T Taupe	
HST3008T Gray	

• **DIVISION MOLDING 96.00" & 120.00"**

This product is used to cover the seams of the Handi-wall panels.

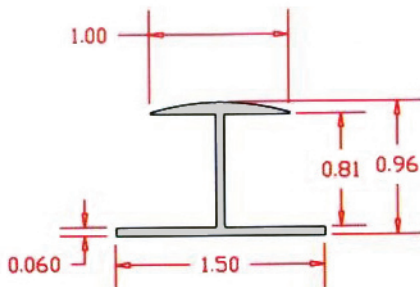

• **PART NUMBERS**

HST1008D White 96"	HST4008D Black 96"
HST1108D White 120"	HST4108D Black 120"
HST2008D Taupe 96"	HST5108D Burgundy 120"
HST2108D Taupe 120"	HST9008D Maple 96"
HST3008D Gray 96"	HST9108D Maple 120"
HST3108D Gray 120"	